

# Tilt

## LCD/PLASMA Wall Mount









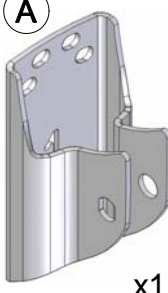

Assembly instructions

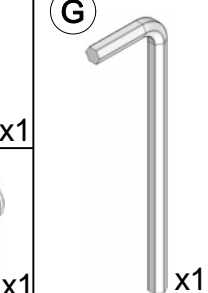

model  
**21**

**CAUTION** - This LCD/Plasma mount is intended for use only with the maximum weights indicated. Use with products heavier than the maximum weights indicated may result in instability causing possible injury.

Fits Up to <b>24"</b> 61 cm LCD/Plasma		
	US 66 lbs	EU 30 kg

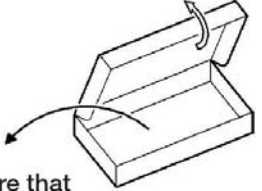
<b>A</b>  x1	<b>D</b>  x1	<b>B</b>  x1	<b>F</b>  x3	<b>O</b>  x1	<b>G</b>  x1	<b>N</b>  x4	<b>H</b>  x1
1:5			1:2		1:1		
<b>J</b>  x2 	<b>M</b>  x2	The provided M bolts may change in size according to the evolution of screen market requirements				 Please make sure that package contains all parts	
1:1							



**Stud finder**

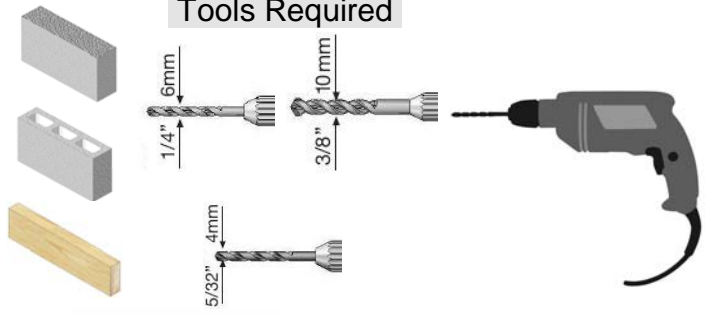

**Tools Required**



6mm, 10mm, 1/4", 3/8", 4mm, 5/32"



No.2+3  
Min 13.8"/35cm

**1**



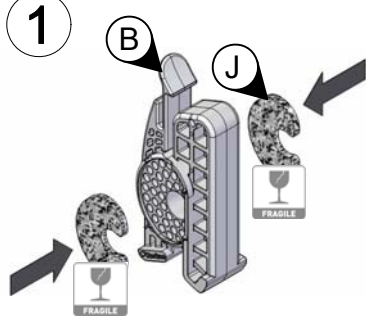

Back of screen

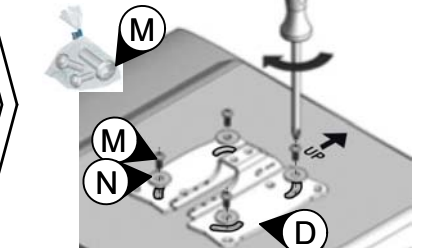



**3**

Wood stud wall



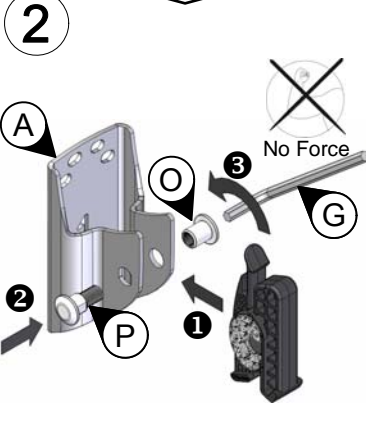

**2**



No Force

Back of screen



Back of screen

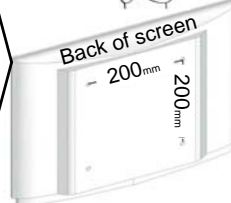
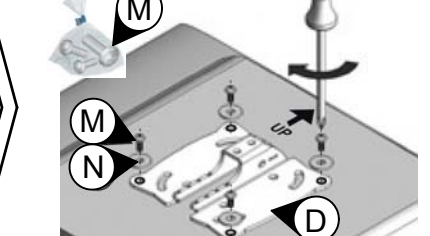

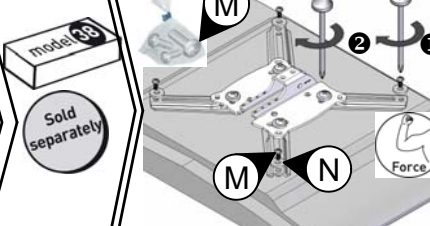



Sold separately

Force

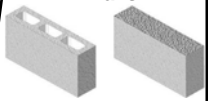
Concrete, Solid bricks or Hollow concrete block walls



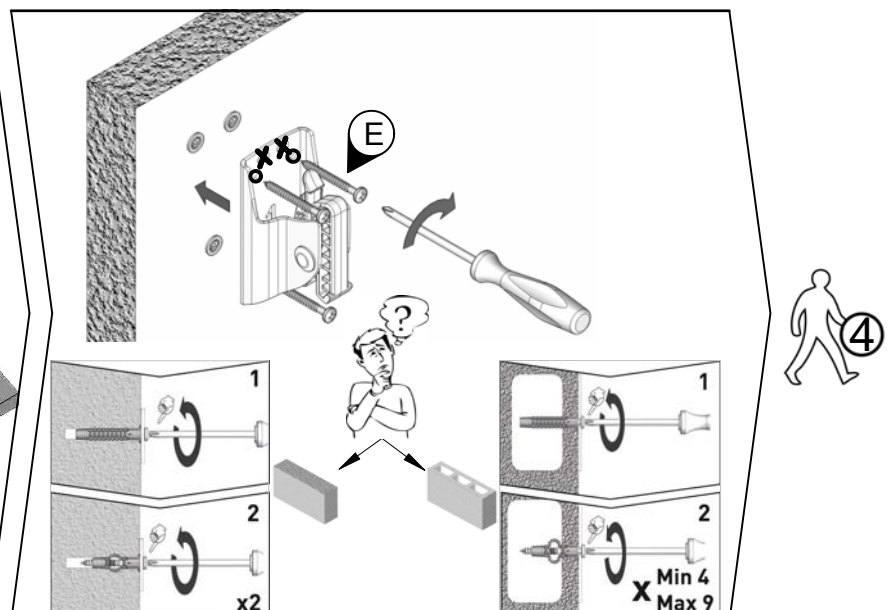
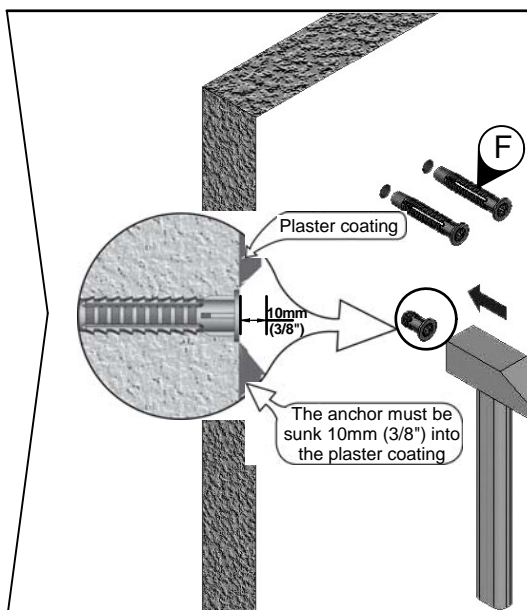
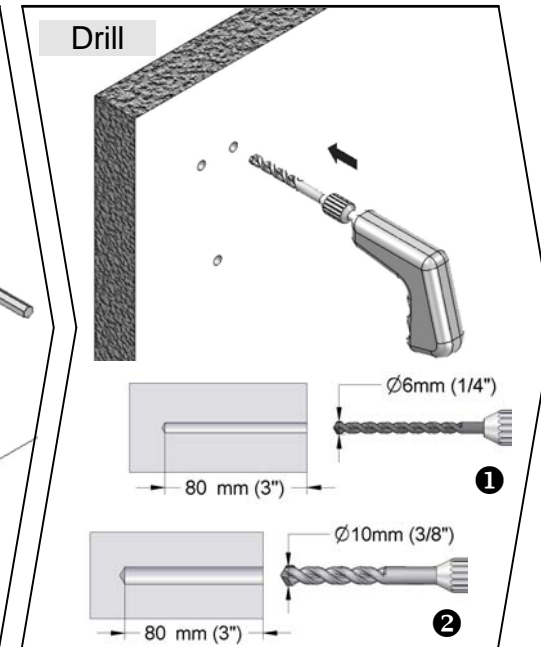
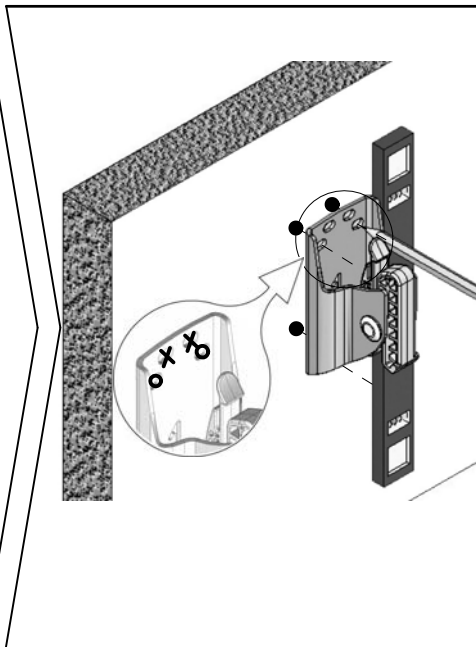
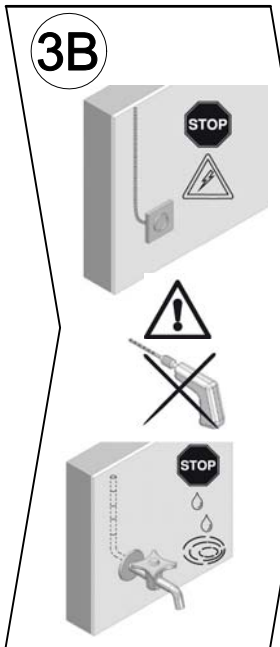
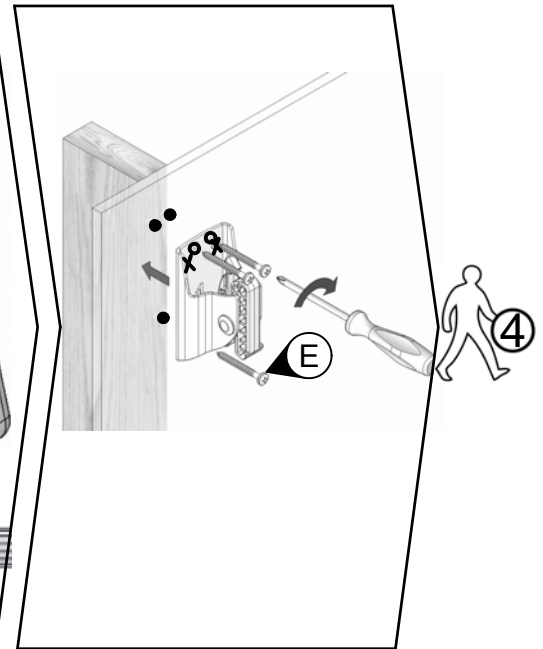
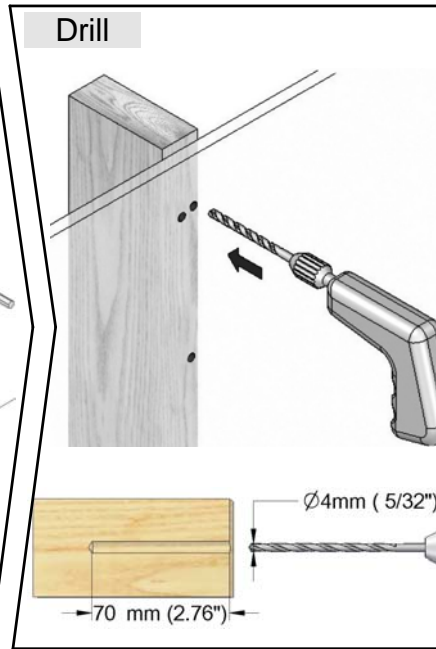
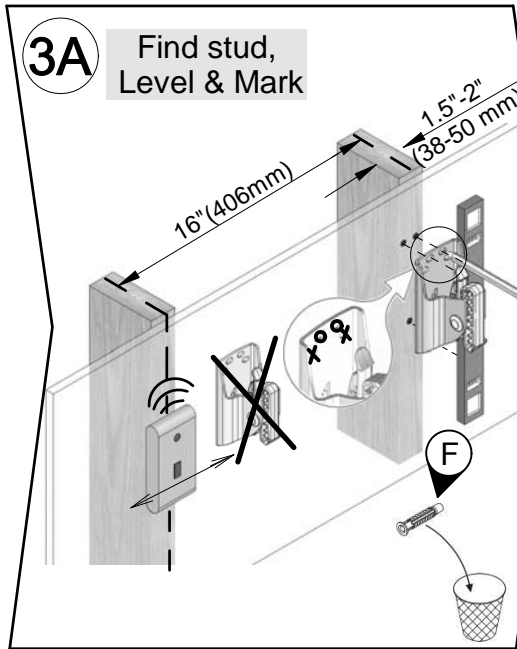

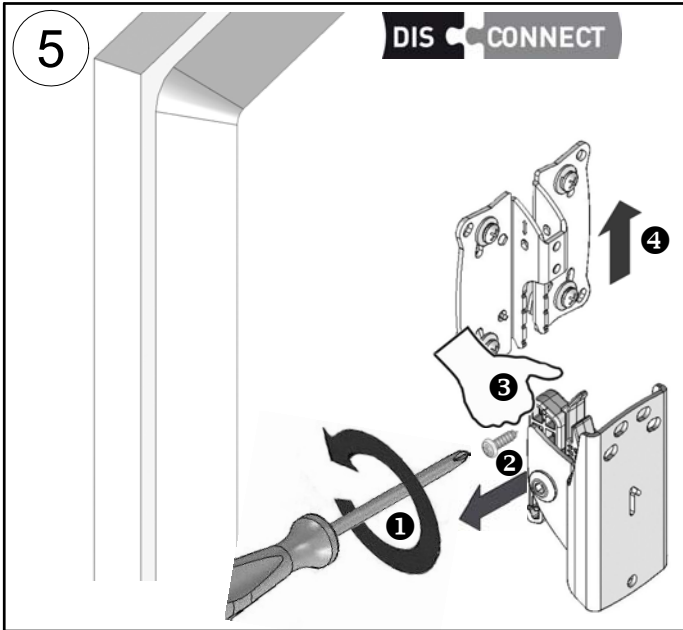
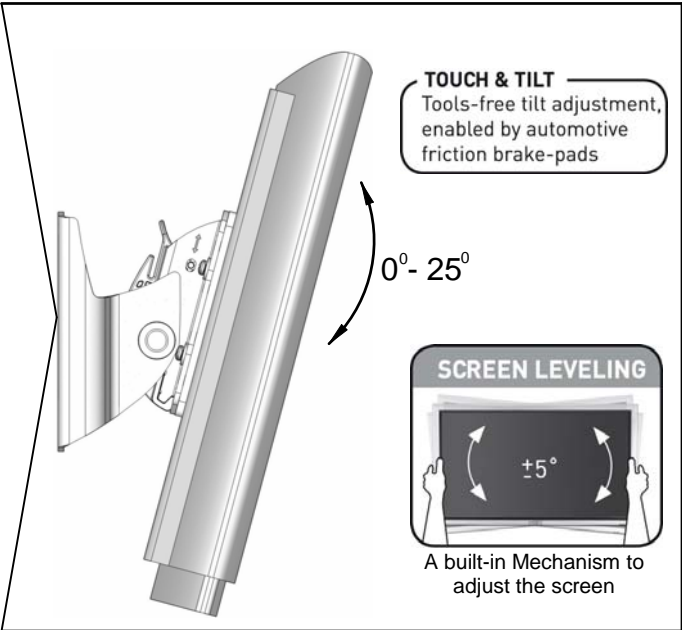
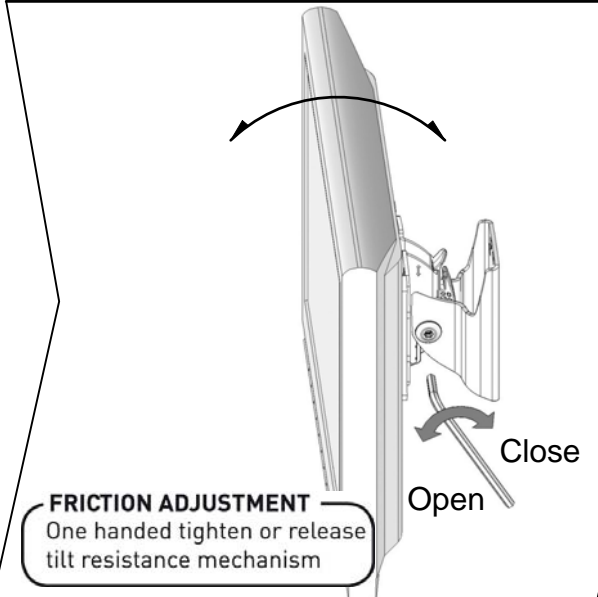
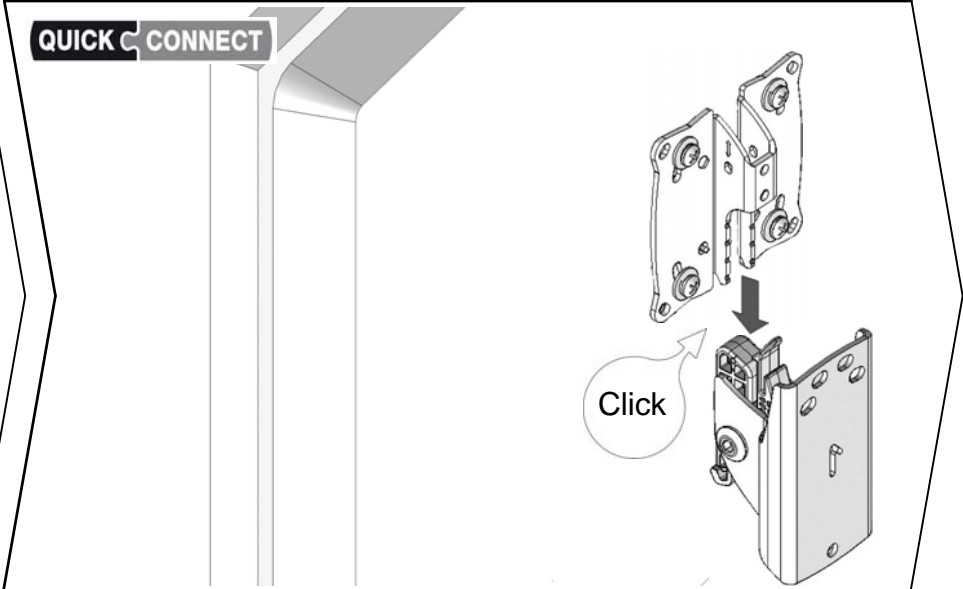
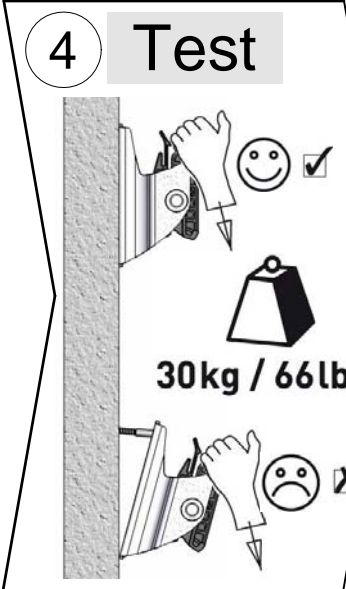
Dear customer, we welcome your comments and suggestions to improve our products, ease of assembly and instructions. Please contact us via our website: [www.barkanmounts.com](http://www.barkanmounts.com)