

Swivel & Tilt LCD/PLASMA CEILING MOUNT

Safety & assembly instructions

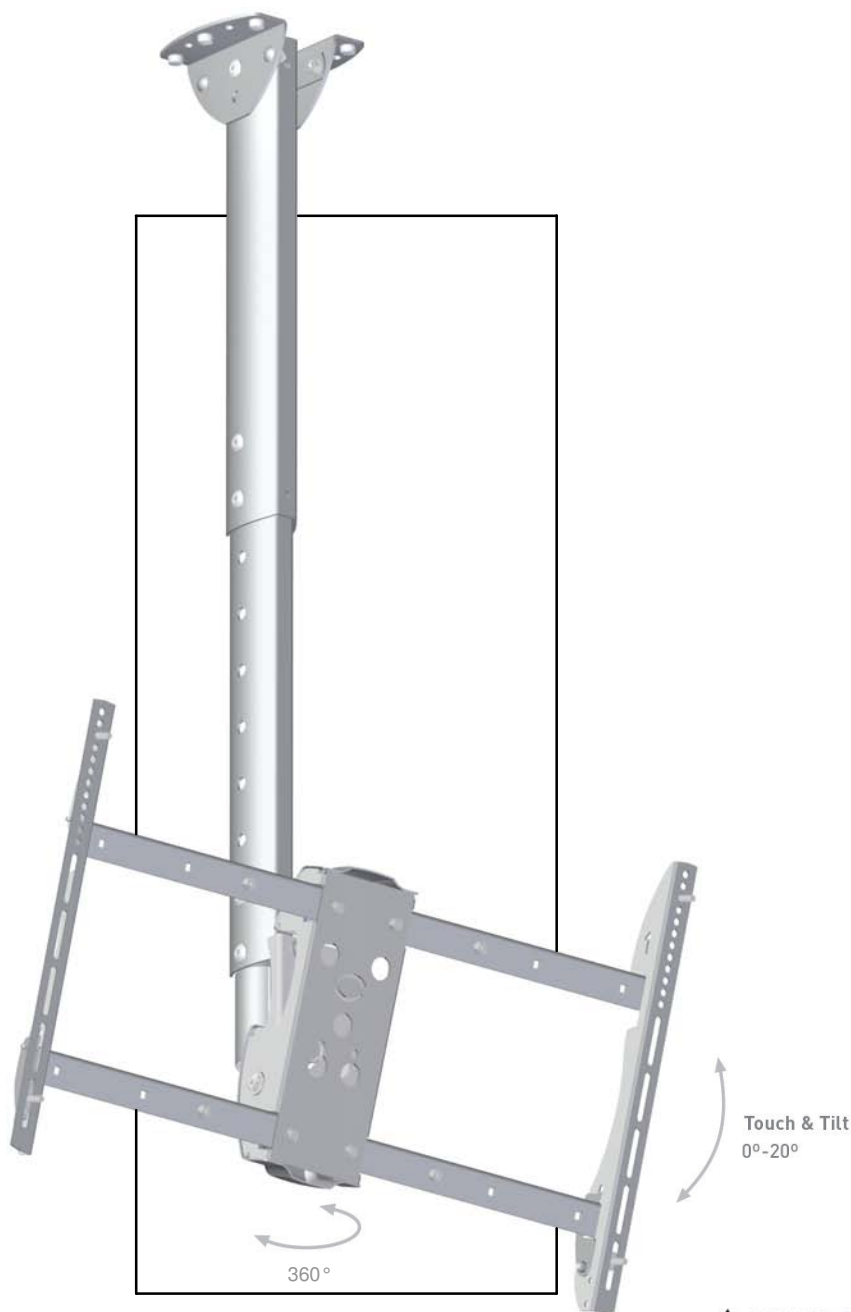



















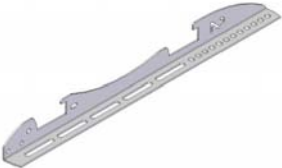









model

45M

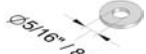

⚠ CAUTION - This LCD/Plasma mount is intended for use only with the maximum weights indicated. Use with products heavier than the maximum weights indicated may result in instability causing possible injury.





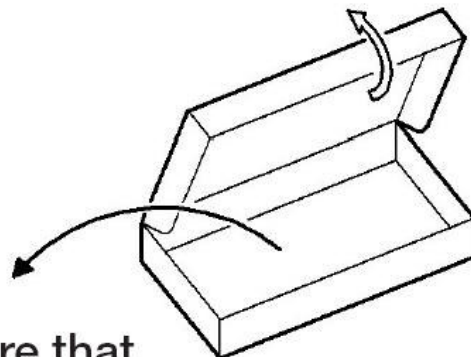

Fits Up to 60" 152cm LCD/Plasma	Max	
	US 132lbs	EU 60kg

1:10	(A)  x1	(B)  x1	(C)  x1	(D)  x1	(E)  x1	
	(F)  x1	(G)  x2	(H)  x1	(I)  x4	(J)  x2	
	(K)  x1	(L)  x1	(M)  x1 <small>The provided Screen bolts may change in size according to changing screen requirements</small>			
1:5	(O)  x2	(P)  x1	(Q)  x2			
	1:2	(R)  x12	(S)  x6	(T)  $\varnothing 1/4" / 6.4 \text{ mm}$ x6	(U)  x6	(V)  $1/2" / 12.7 \text{ mm}$ x2
(W)  x12		(X)  x2	(Y)  x2	(Z)  x14	(AA)  $\varnothing 5/16" / 8.7 \text{ mm}$ x6	
(AB)  $1.9" / 48 \text{ mm}$ x2		(AC)  $2.2" / 56 \text{ mm}$ x1	(AD)  $1.8" / 45 \text{ mm}$ x2	(AE)  $2.2" / 55 \text{ mm}$ x2	(AF)  $2.6" / 65 \text{ mm}$ x1	(AG)  x6

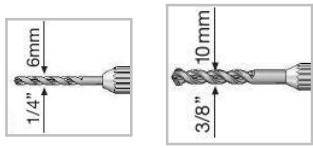

Please make sure that package contains all parts

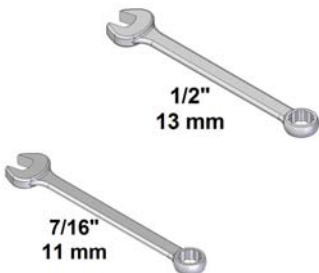
Tools Required

			
			

1

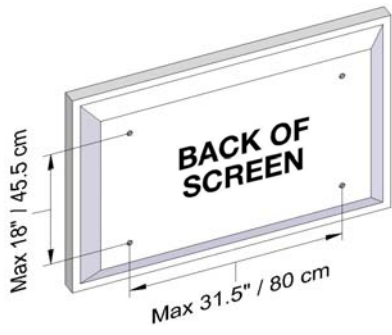

BACK OF SCREEN

Bracket assembly to screen

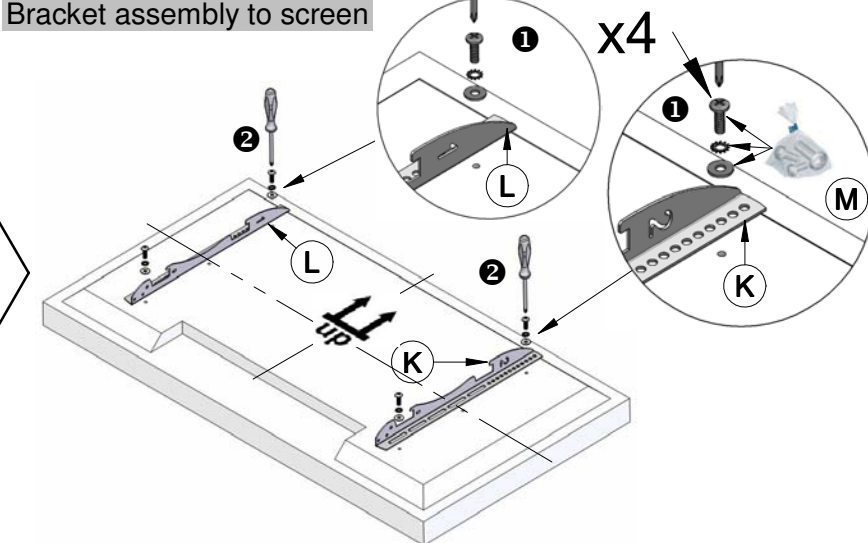

Assemble bracket in center

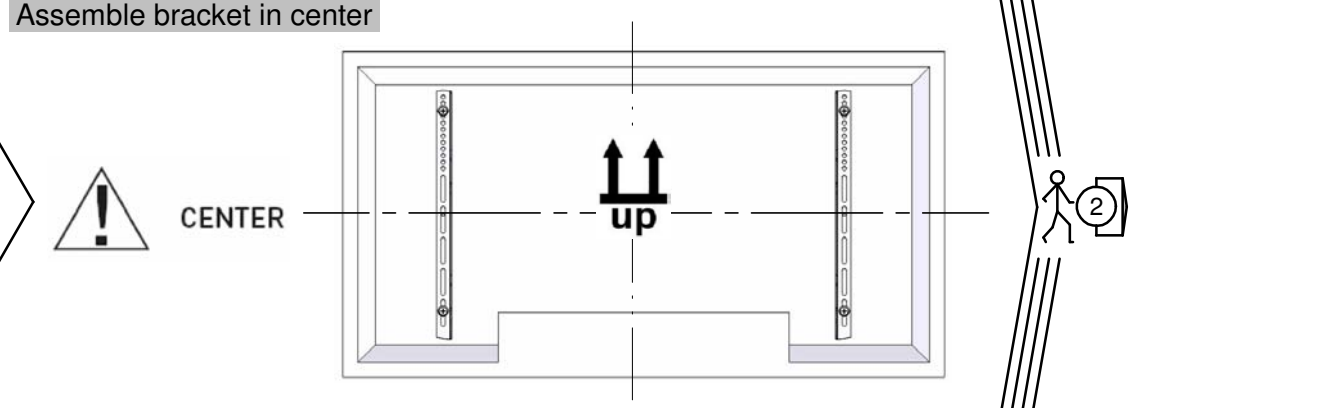

up

2

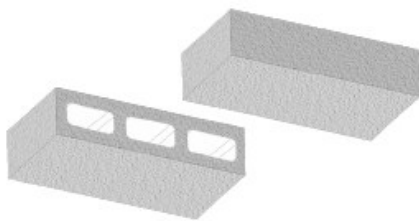

Concrete,
concrete hollow
blocks or
heavy solid
bricks ceiling

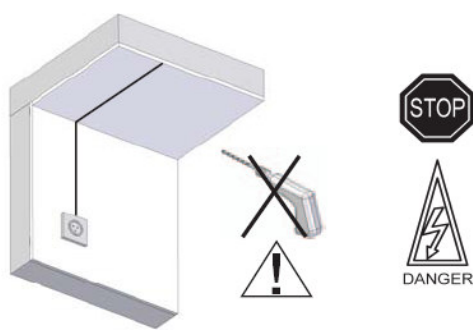

STOP
DANGER

Arm Assembly

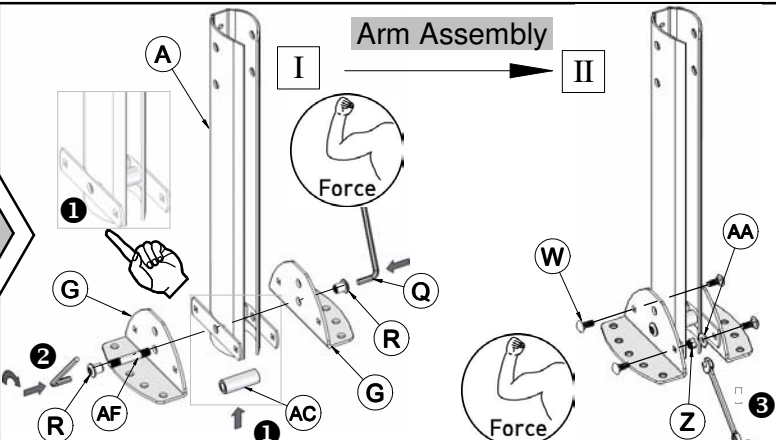

I → **II**

Force

Level & mark

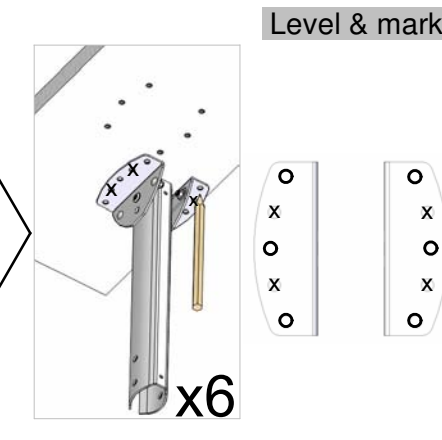

x6

Drill

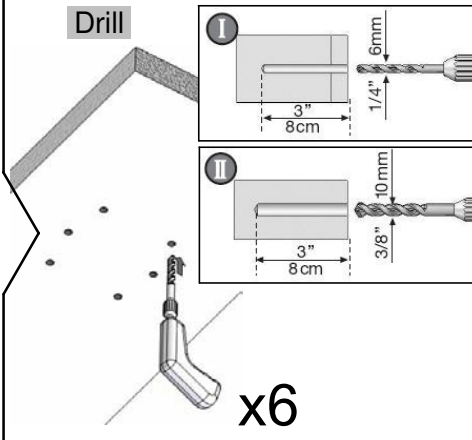

I 6mm 1/4" 3" 8cm

II 10mm 3/8" 3" 8cm

x6

Insert anchors

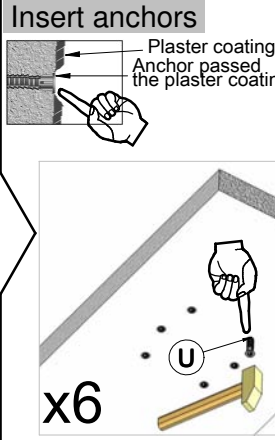

Plaster coating
Anchor passed
the plaster coating

x6

Assembly to ceiling

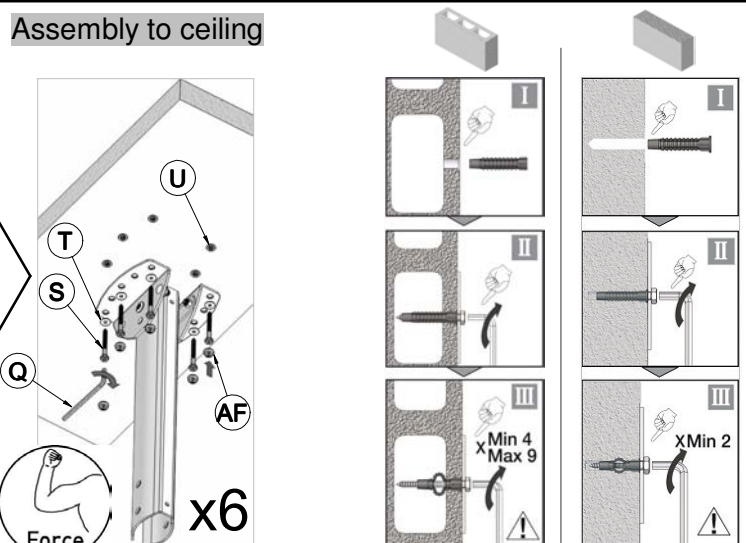

U, **T**, **S**, **Q**, **AF**

Force

x6

I, **II**, **III**

Min 4
Max 9

XMin 2

TEST

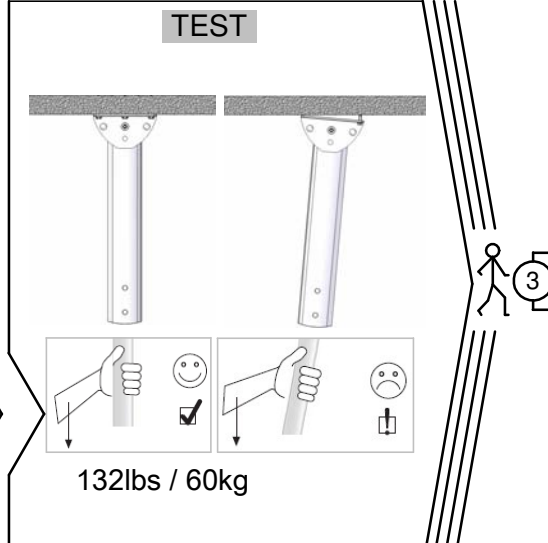

3

132lbs / 60kg

